

**MEMS**  
INTERNATIONAL

**SOCIAL DISTANCING SOLUTIONS TO KEEP  
YOUR CUSTOMERS AND EMPLOYEES SAFE**

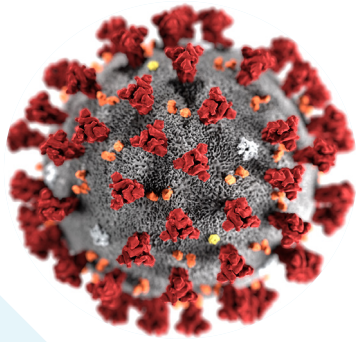



PAGE 3	INTRODUCTION
PAGE 4	HAND SANITISER STATION
PAGE 5	HYGIENE SCREENS
PAGE 6 - 8	OFFICE CUBICLES
PAGE 9	GRAPHIC WALLS
PAGE 10	QUEUING SYSTEM
PAGE 11	SAFETY GRAPHICS
PAGE 12	POCKET GUIDES
PAGE 13	POSTERS
PAGE 14	PULL UP BANNERS
PAGE 15	LARGE SIGNAGE
PAGE 16	FLOOR GRAPHICS
PAGE 17	STAIR GRAPHICS
PAGE 18	COVID-19 PREMISES DECONTAMINATION
PAGE 19	CONTACT DETAILS

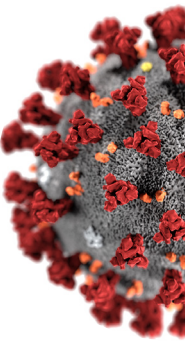

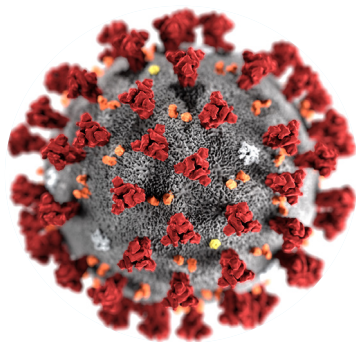

MEMS International is a specialist producer of display graphics, exhibition stands and signage and can now offer a full suite of safety solutions for businesses to keep their customers and staff safe as lock down measures are gradually eased.

Our in-house exhibition system is available to rent or purchase and provides a modular solution that is quick and simple to configure into a range of structures. It can be deployed quickly in office, retail and hospitality spaces to protect staff and customers and ensure they conform with social distancing guidelines.

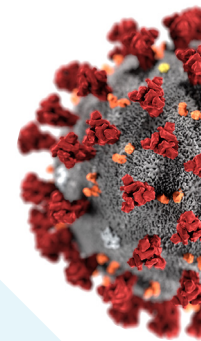

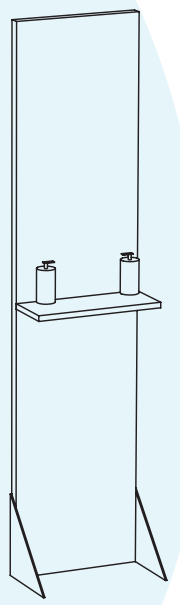
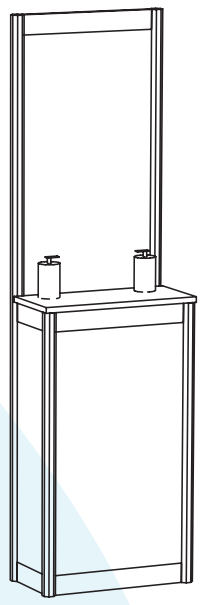

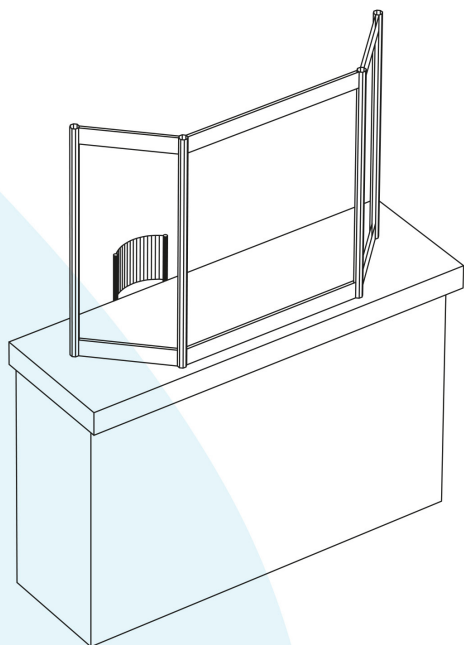

800mm (h) x 6500mm (w) 5mm thick acrylic screen that can be branded with a logo



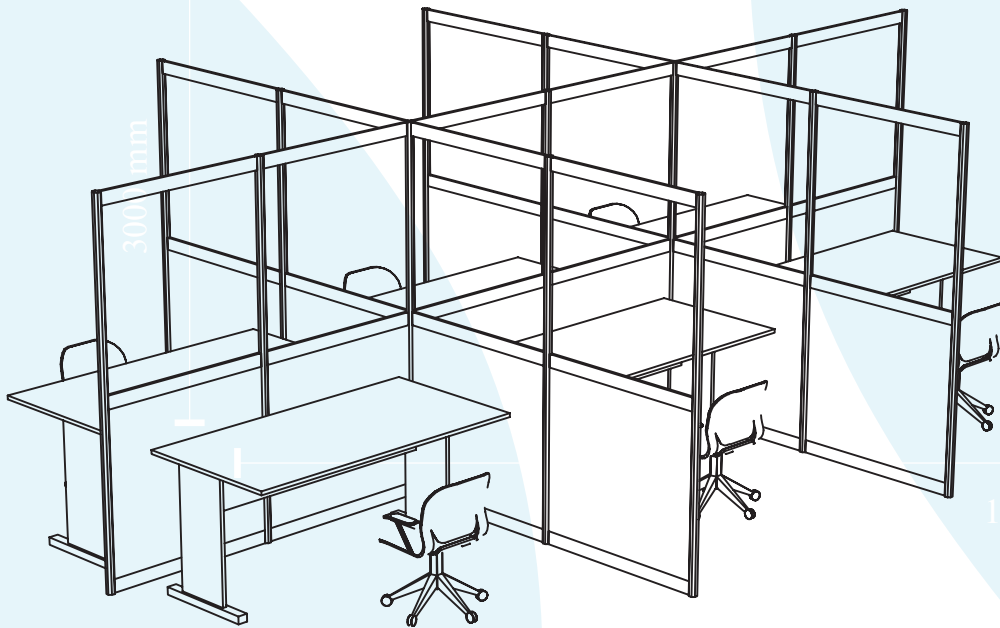

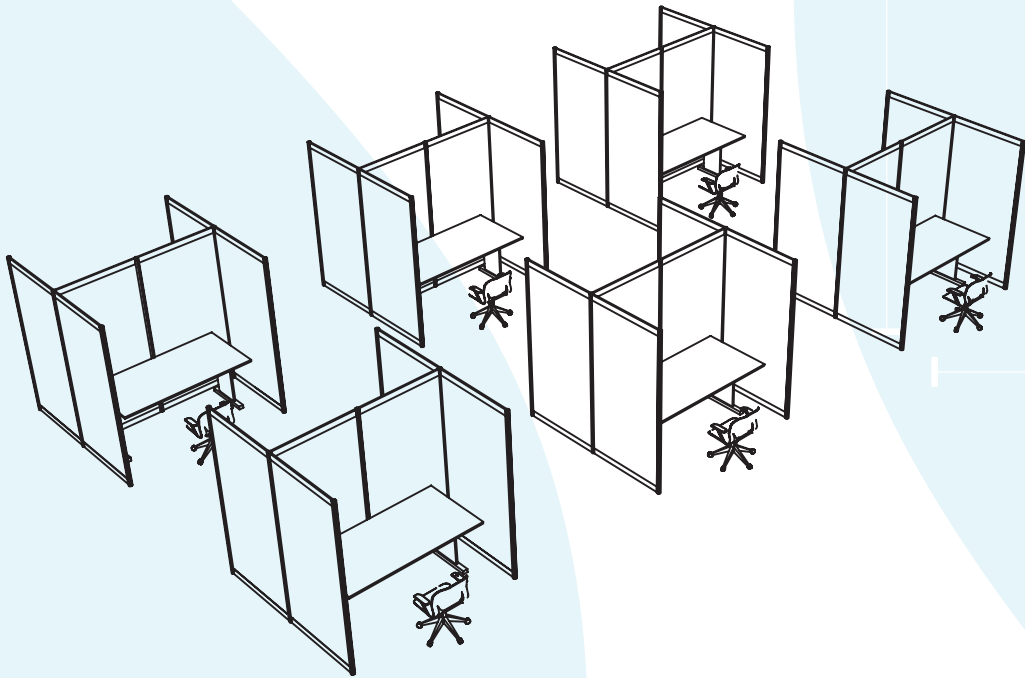

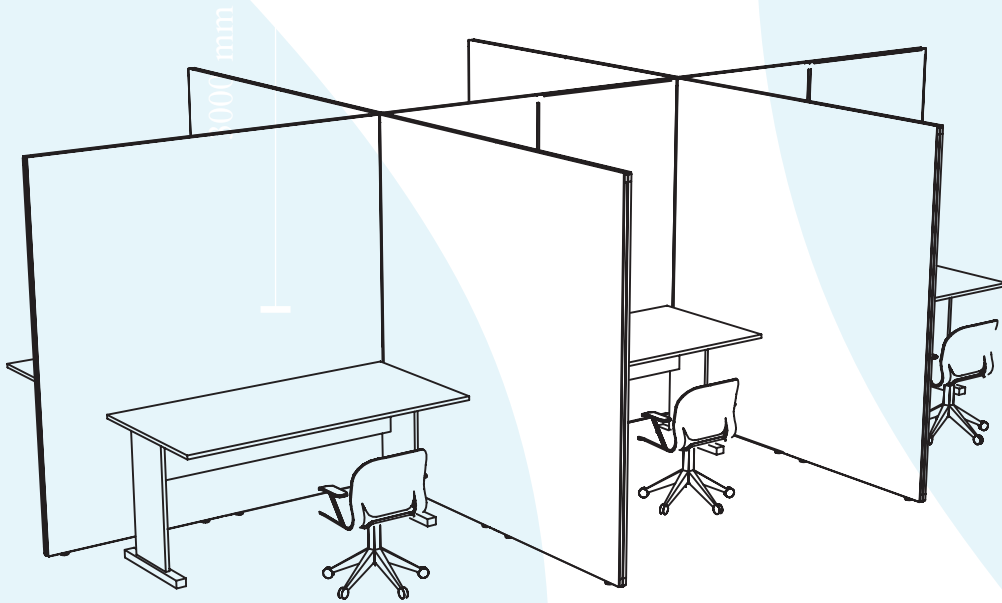



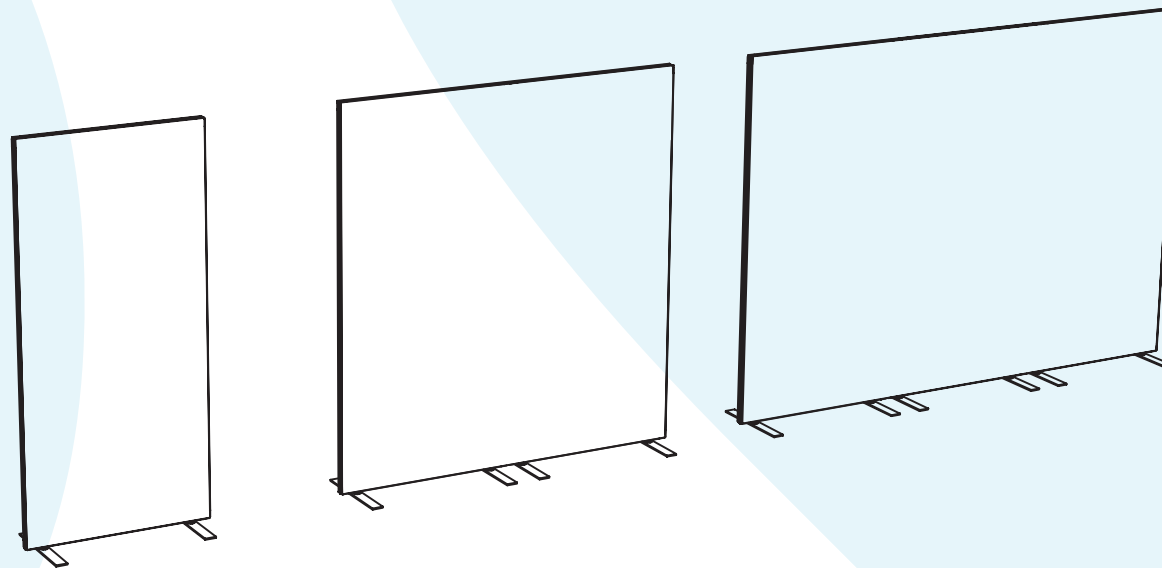

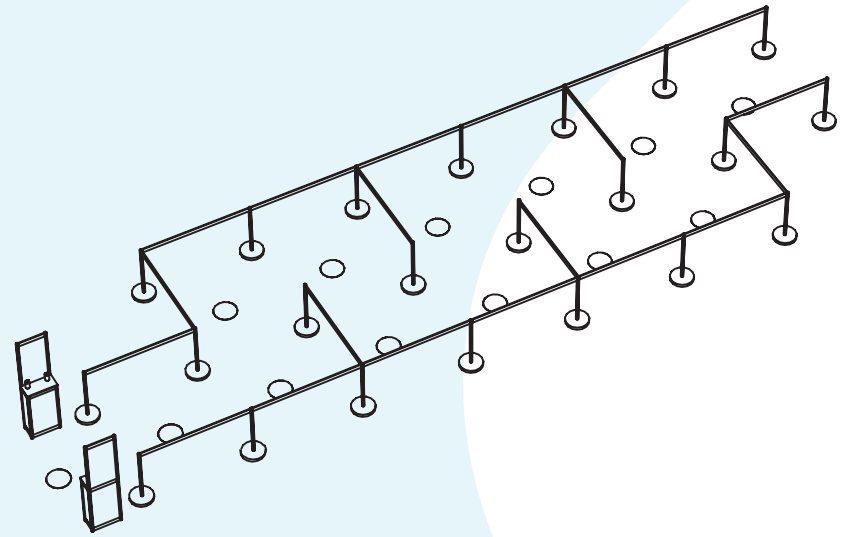

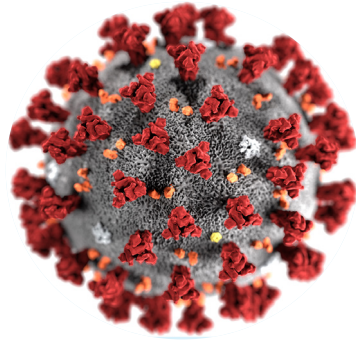

Our safety graphics catalogue features a range of leaflets, posters and floor graphics that can be used in the workplace, providing information and advice for managers and staff.

Branded versions, incorporating your company logo and brand colours, are available upon request. Changes to overall design, typography and illustrations/icons would require the production of custom designs, which our team would be happy to discuss with you.

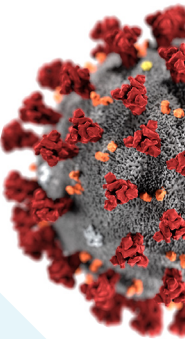

A handy eight page business card sized leaflet suitable for distribution to all staff as a handy 'quick' guide to core information and health service advice relating to coronavirus. Size: 85mm x 55mm when folded.



Posters for use throughout the workplace are available in a variety of sizes from A0 to A5 in a variety of finishes and media.

Sentry Poster and Snap Frame Display in A4 and A3. Freestanding and wall mounted with post print insert

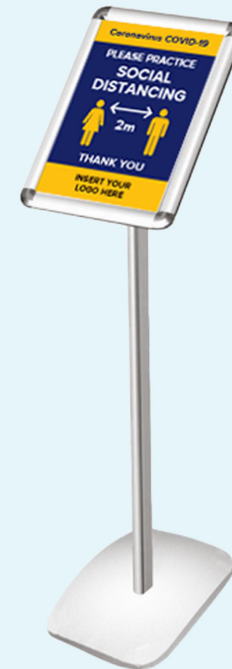

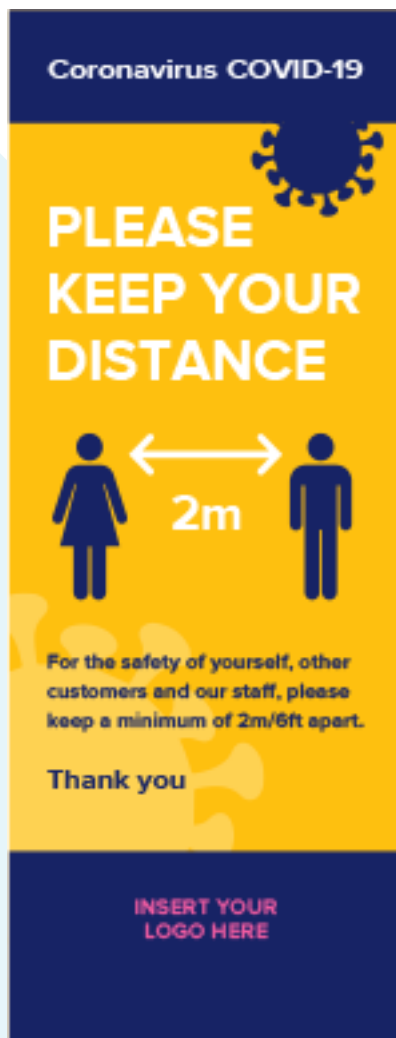

Single and double-sided pull up banners in a variety of sizes

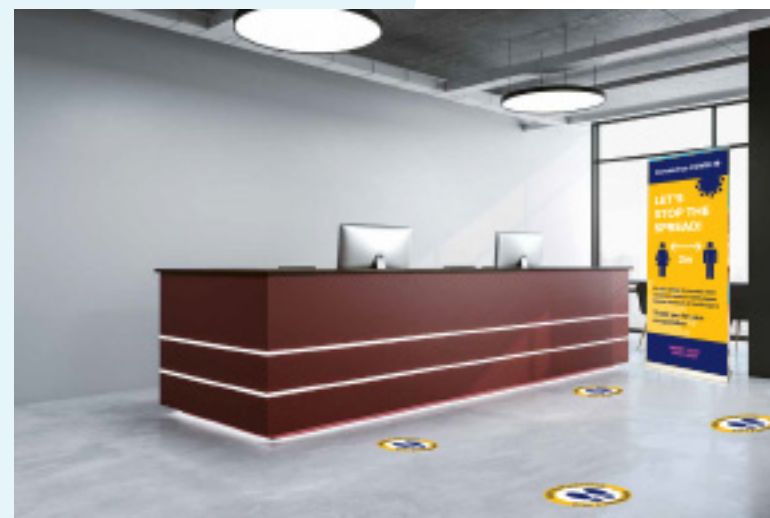

A variety of media for indoor and outdoor use.



Anti-slip floor graphics and tape to help with social distancing.

The round floor stickers are available in 200mm, 400mm and 800mm diameter.

The squares designs are available in 1000mm x 1000mm stickers and 600mm x 600mm 3mm Foamex with anti slip seal for carpet tiles.

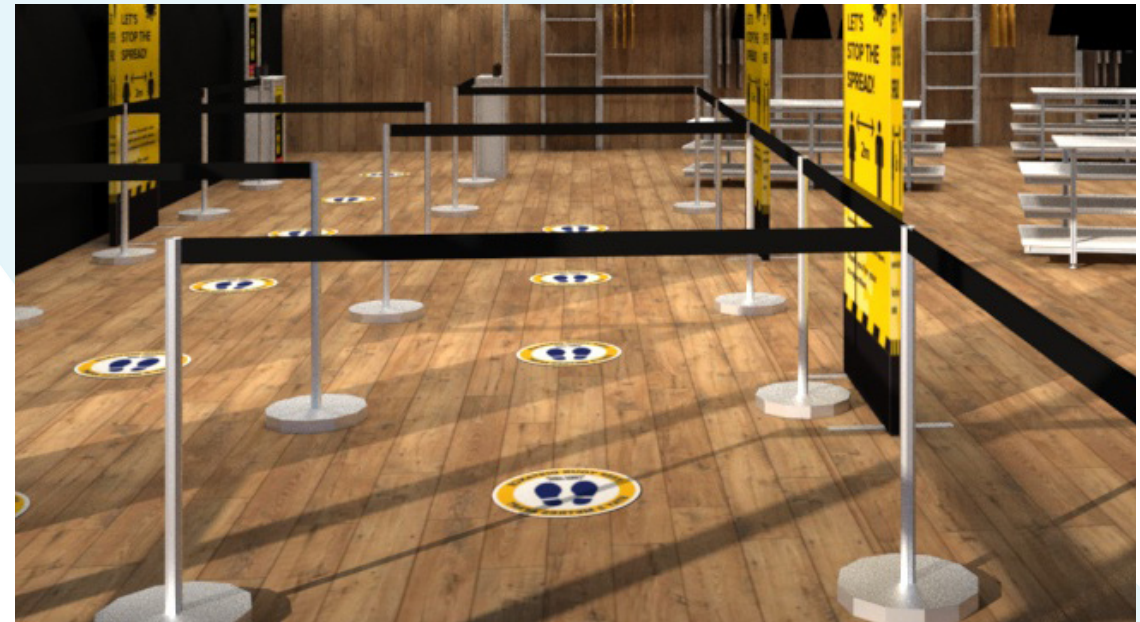
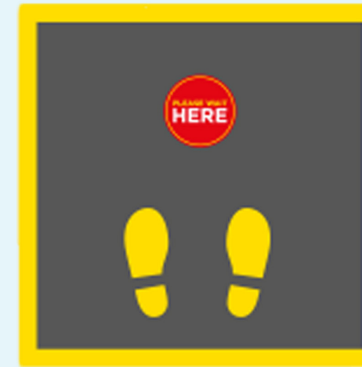



Social distancing stair graphics and double sided 450mm disc balustrading graphics

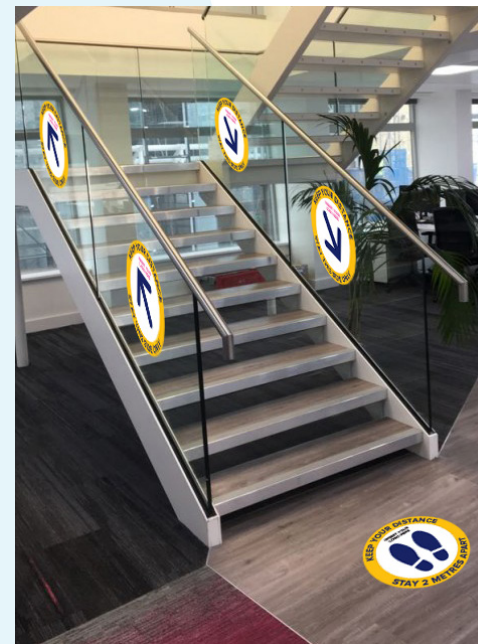

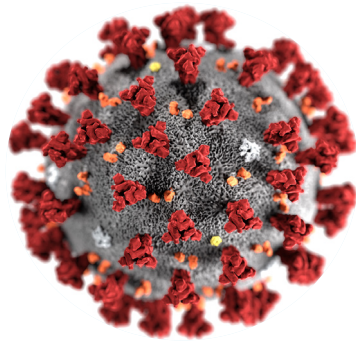

Are you preparing for opening after lockdown? MEMS International alongside our trusted cleaning partners can provide a complete disinfection clean for your workplace to protect your staff and clients. We specialise in COVID-19 deep cleaning, disinfection, and bio-fogging services.

- 99.99% effective
- Eliminates biological & chemical VOCs
- Destroys viruses and bacteria
- Environmentally friendly & non-toxic

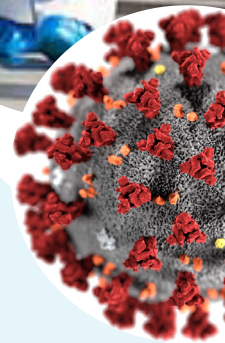

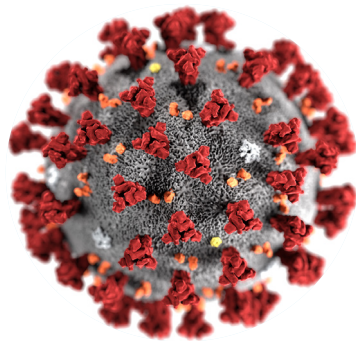

ESSA | Event Supplier and  
Services Association



International Federation  
of Exhibition  
and Event Services



MEMS International Limited,  
Exhibition House,  
Cox Lane,  
Chessington,  
Surrey,  
KT9 1TT

Phone: +44 (0)20 89741781  
Email: [exhibit@mems.co.uk](mailto:exhibit@mems.co.uk)